

KYRA-26V5L-WT

Kyra-LED

WiFi & RF 5 in1 LED Controller

- 5 in 1 function, used for control RGB, RGBW, RGB+CCT, color temperature or single color LED strip.
- DC12-48V input, 5 channel constant voltage output.
- Tuya smart APP cloud control, support on/off, RGB color, color temperature and brightness adjust, delay turn on/off light, timer run, scene edit and music play function.
- Voice control, support for Amazon Alexa, Google Assistant, Tmall Genie and Xiaodu voice assistant.
- Match with RF 2.4G remote control optional.
- User need set light type before Tuya smart APP network connection and match RF remote of the same light type.
- Each KYRA-26V5L-WT controller can also work as WiFi+RF converter, then use Tuya smart APP to control one or more RF LED controller or RF LED dimming driver synchronously.
- PWM frequency 500Hz, 2000Hz, 8000Hz or 16000Hz selectable.
- Light on/off fade time 3s selectable.
- Connect with external push switch to achieve on/off and 0-100% dimming function.

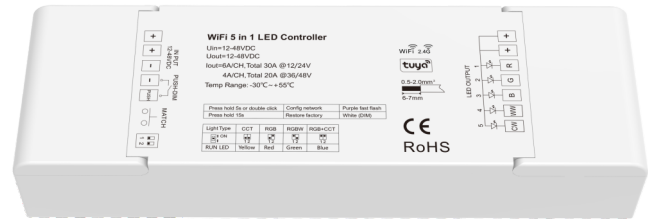

CE RoHS

Technical Parameters

Input and Output		Dimming data		Safety and EMC	
Input voltage	12-48VDC	Input signal	WiFi + RF 2.4GHz + Push-DIM	EMC standard	EN IEC 55015/EN IEC 61547 ETSI EN 301 489-1/-3/-17
Input current	30.5A	Control distance	30m(Barrier-free space)	Safety standard	EN 61347-1/-2
Output voltage	5 x (12-48)VDC	Dimming gray scale	4096 (2^12) levels	Radio Equipment	ETSI EN 300 440 ETSI EN 300 328
Output current	6A/CH@12-24V 4A/CH@36-48V	Dimming range	0-100%	Certification	CE RoHS
Output type	Constant voltage	Dimming curve	Logarithmic	Package	
Warranty and Protection		PWM Frequency	2000Hz (default)	Size	1185 x W58 x H36mm
Warranty	5 years	Environment		Gross weight	0.193kg
Protection	Reverse polarity Short circuit Over heat	Operation temperature	Ta: -30 °C ~ +55 °C		
		Case temperature (Max.)	Tc: +85 °C		
		IP rating	IP20		

Mechanical Structures and Installations

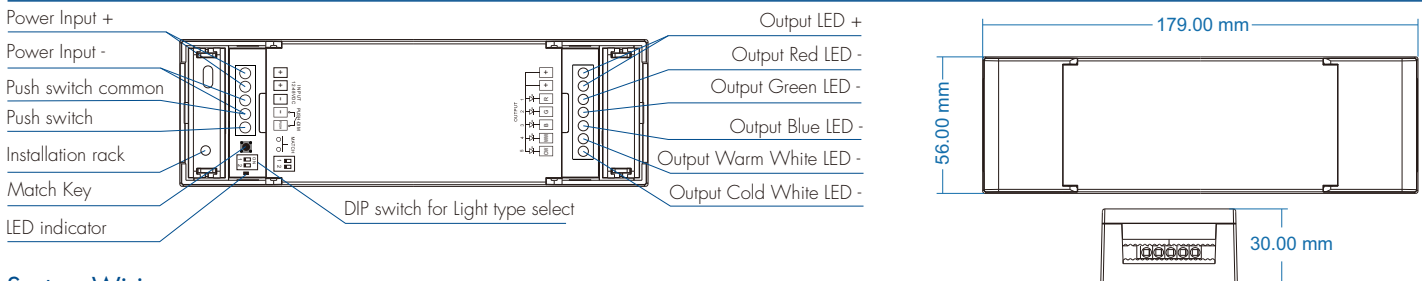

System Wiring

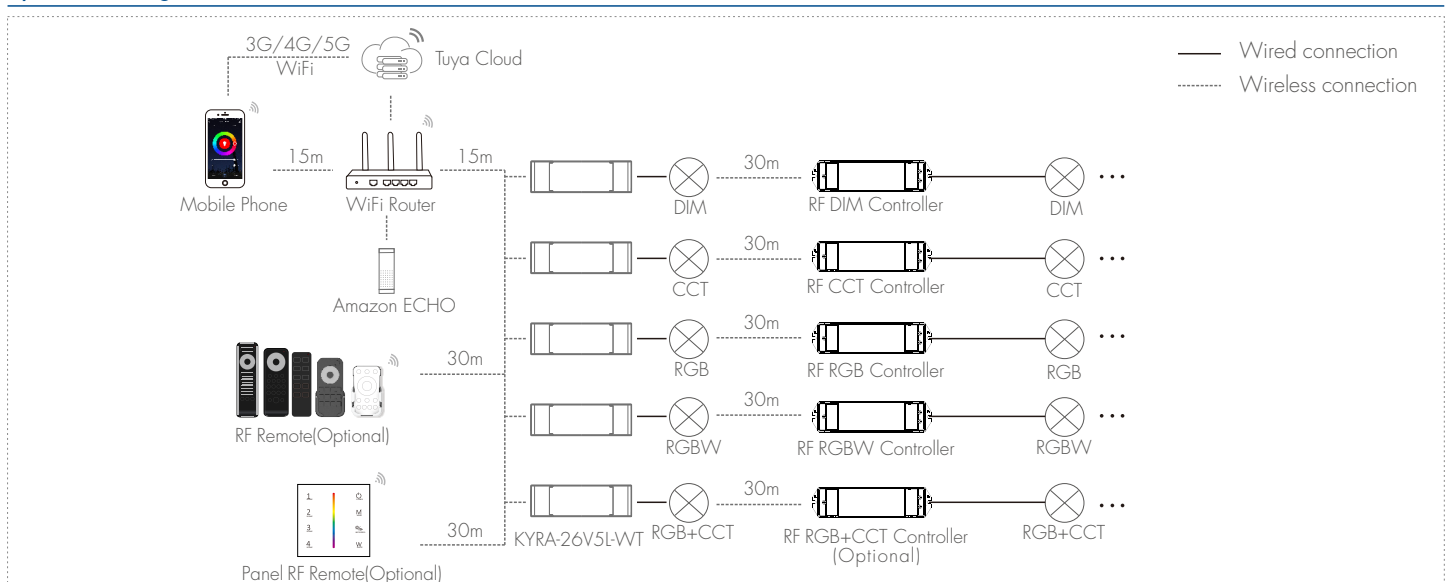

- Note: 1. The above distance is measured in spacious (no obstacle) environment, please refer to the actual test distance before installation.
 2. Please check if the WiFi router net in 2.4G band, the 5G band is not available, and do not hide your router network.
 3. Please keep the distance between KYRA-26V5L-WT devices and router close, and check the WiFi signals.

Wiring Diagram

• For RGB+CCT

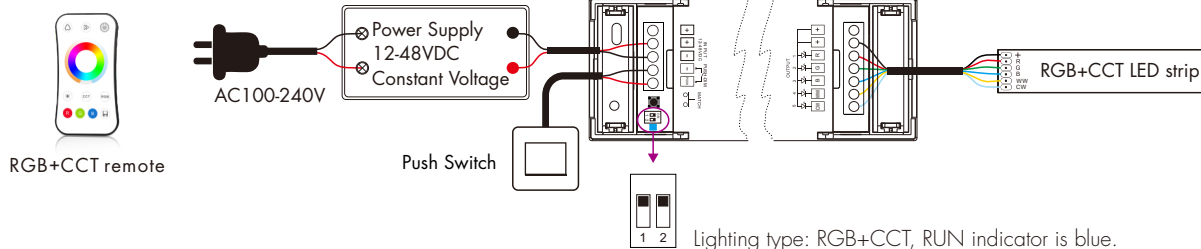

• For RGBW

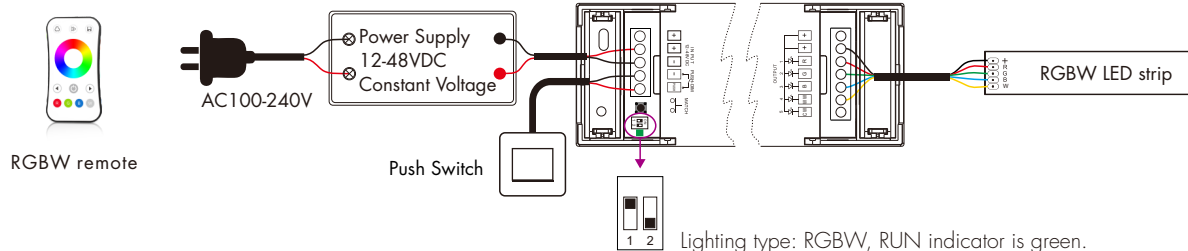

• For RGB

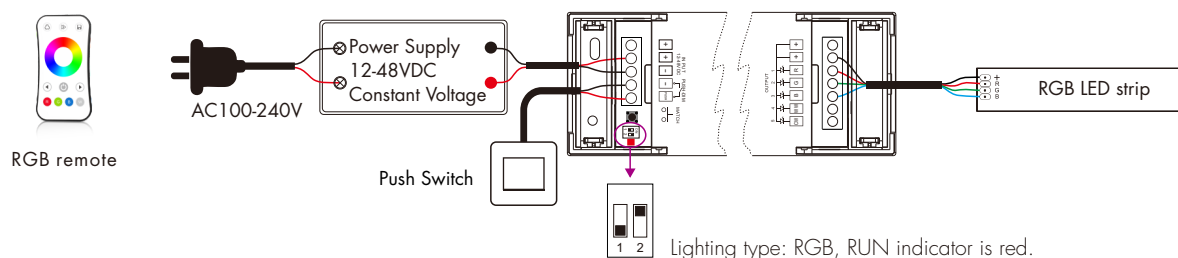

• For dual color CCT

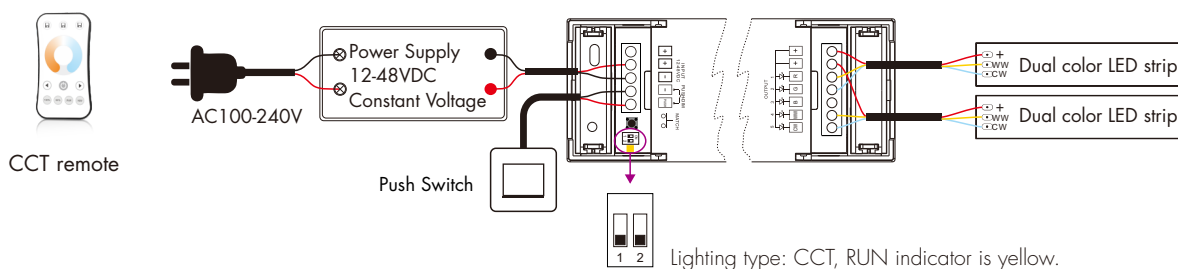

• For single color

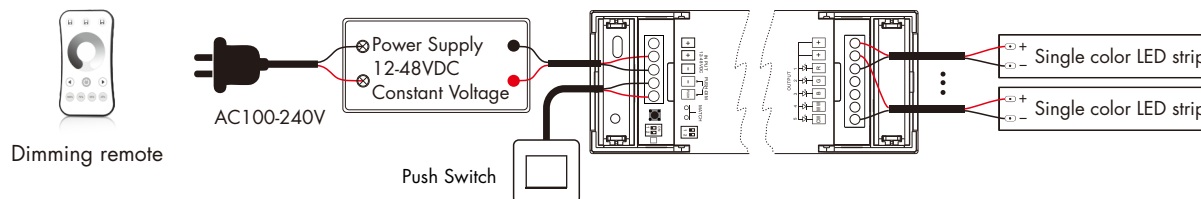

Press and hold MATCH key for 1.5s, until the RUN LED indicator turn white, then release, the controller will become DIM type, the light on/off time also restore to 0.5s, the output PWM frequency also restore to 2000Hz.

Note:

1. After changed the light type by DIP switch, please redo the Tuya smart APP config operation.
2. For RGB+CCT or CCT light type, continuous power on and off will change 3 levels color temperature (WW, NW and CW) in sequence.
3. Switch off the power, then switch on power, repeat again. Immediately short press match key 3 times, the light on/off time will change between 3s and 0.5s.

Tuya Smart APP Network Connection

Press and hold Match key for 5s, or push twice Match key fastly:

Clear previous network connection, enter WiFi config mode, the LED indicator flash fastly, the output LED will flash 10 times.

Repeat power on and off for 5 consecutive times, also clear previous network connection, enter WiFi config mode, the output LED will flash 10 times.

If Tuya smart APP network connection succeed, the RUN LED indicator will stop flash purple, and turn corresponding light type color (White: DIM, Yellow: CCT, Red: RGB, Green: RGBW, Blue: RGB+CCT). and in Tuya smart APP, you can find RGB+CCT device (or other DIM, CCT, RGB or RGBW).

When controlling the light with Tuya Smart/Smart Life APP, if the network connection is poor, you can control the light with Bluetooth connection within the Bluetooth control range.

Note: The light can not be directly controlled by Bluetooth without WiFi configuration.

Tuya Smart APP Interface

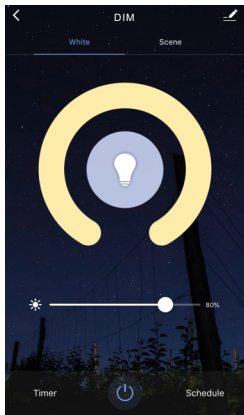

White interface

For DIM type:

Touch brightness slide to adjust brightness.

For RGB type:

Touch brightness slide, get RGB mixed white firstly, then to adjust white brightness.

For RGBW type:

Touch brightness slide, adjust white channel brightness.

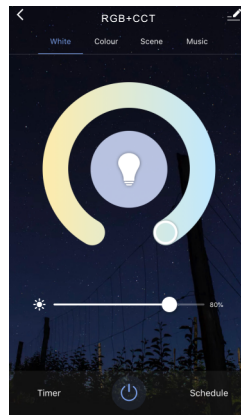

Color temperature interface

For CCT type:

Touch color wheel to adjust color temperature.

Touch brightness slide to adjust brightness.

For RGB+CCT type:

Touch color wheel to adjust color temperature, RGB will turn off automatically.

Touch brightness slide to adjust white brightness.

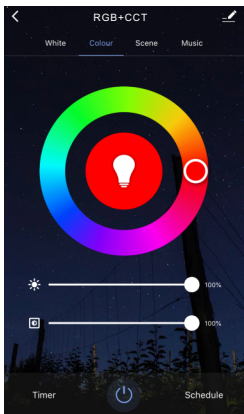

Colour interface

For RGB or RGBW type:

Touch color wheel to adjust static RGB color.

Touch brightness slide to adjust color brightness.

Touch saturation slide to adjust color saturation, namely gradient from the current color to white (RGB mixed).

For RGB+CCT type:

Touch color wheel to adjust static RGB color, WW/CW will turn off automatically.

Touch brightness slide to adjust color brightness.

Touch saturation slide to adjust color saturation, namely gradient from the current color to white (RGB mixed).

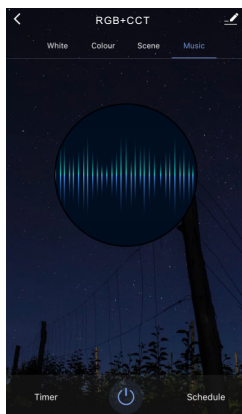

Scene interface

- The 1-4 scene is static color for all light type. the inner color of these scene can be editable.
- The 5-8 scene is dynamic mode for RGB, RGBW, RGB+CCT type, such as green fade in and fade out, RGB jump, 6 color jump, 6 color smooth.

Music, Timer, Schedule

- The music play can use smart phone music player or microphone as music signal input.
- The Timer key can turn on or turn off light in the next 24 hours.
- The Schedule key can add multiple timers to turn on or turn off light according to different time periods.

KYRA-26V5L-WT Match Remote Control (Optional)

End user can choose the suitable match/delete ways. Two options are offered for selection:

Use the KYRA-26V5L-WT's Match key

Match:

Short press match key of KYRA-26V5L-WT, immediately press on/off key (single zone remote) or zone key (multiple zone remote) on the remote.

The LED indicator fast flash a few times means match is successful.

Delete:

Press and hold match key of KYRA-26V5L-WT for 10s, The LED indicator fast flash a few times means all matched remotes were deleted.

Use Power Restart

Match:

Switch off the power of KYRA-26V5L-WT, then switch on power, repeat again. Immediately short press on/off key (single zone remote) or zone key (multiple zone remote) 3 times on the remote. The light blinks 3 times means match is successful.

Delete:

Switch off the power of KYRA-26V5L-WT, then switch on power, repeat again. Immediately short press on/off key (single zone remote) or zone key (multiple zone remote) 5 times on the remote. The light blinks 5 times means all matched remotes were deleted.

KYRA-26V5L-WT Work as WiFi-RF Converter to Match RF LED Controller or Dimming Driver

End user can choose the suitable match/delete ways. Two options are offered for selection:

Use the controller's Match key

Match:

Short press match key of the controller, immediately press on/off key on the Tuya smart APP. The LED indicator fast flash a few times means match is successful.

Delete:

Press and hold match key of the controller for 5s, The LED indicator fast flash a few times means match was deleted.

Use Power Restart

Match:

Switch off the power of the controller, then switch on power, repeat again. Immediately short press on/off key 3 times on the Tuya smart APP. The light blinks 3 times means match is successful.

Delete:

Switch off the power of the controller, then switch on power, repeat again. Immediately short press on/off key 5 times on the Tuya smart APP. The light blinks 5 times means match was deleted.

PWM Frequency Setting

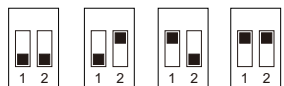

500Hz 2000Hz 8000Hz 16000Hz

When power is off, select the DIP switch firstly, then press hold the MATCH key, and power up the controller in the same time, the RUN LED indicator will flash white color two times means PWM frequency setting is successful.

We can select four PWM frequency: 500Hz, 2000Hz, 8000Hz or 16000Hz.

Higher PWM frequency, will cause lower output current, higher power noise, but more suitable for camera(No flickers for video).

Push Dim

Single color	Click	ON/OFF
	Double Click	Turn on at 100% or 10%(night light) and vice-versa
	Long press(> 1s) from OFF	Dimming UP/DOWN
	Long press(> 1s) from ON	Dimming UP/DOWN
Dual Color	Click	ON/OFF
	Double Click	Turn on at 100% or 10%(night light) and vice-versa
	Long press(> 1s) from OFF	Color temperature UP/DOWN (turn off and turn on to return dimming)
	Long press(> 1s) from ON	Dimming UP/DOWN
RGB	Click	ON/OFF
	Double Click	Change from color mode to white mode (RGB mixed) and vice-versa
	Long press(> 1s) from OFF	If on color mode change rotation speed; If on white mode dimming UP/DOWN
	Long press(> 1s) from ON	If on color mode start/stop color rotation; If on white mode dimming UP/DOWN
RGBW	Click	ON/OFF
	Double Click	Change between color mode, white mode (W channel) and color+W mode
	Long press(> 1s) from OFF	If on color mode change rotation speed; If on white mode or color+W mode, W dimming UP/DOWN
	Long press(> 1s) from ON	If on color mode start/stop color rotation; If on white mode or color+W mode, W dimming UP/DOWN
RGB+CCT	Click	ON/OFF
	Double Click	Change from color mode to tunable white mode and vice-versa
	Long press(> 1s) from OFF	If on color mode change rotation speed; If on tunable white mode color temperature UP/DOWN (turn off and turn on to return dimming)
	Long press(> 1s) from ON	If on color mode start/stop color rotation; If on tunable white mode dimming UP/DOWN

Color rotation:



We can select 4 rotation speed:

10 flash/s means 6 seconds color rotation

5 flash/s means 30 seconds color rotation

2 flash/s means 1 minute color rotation

1 flash/s means 6 minutes color rotation

Dynamic Mode List

For RGB/RGBW:

No.	Name	No.	Name
1	RGB jump	6	RGB fade in and out
2	RGB smooth	7	Red fade in and out
3	6 color jump	8	Green fade in and out
4	6 color smooth	9	Blue fade in and out
5	Yellow cyan purple smooth	10	White fade in and out

For RGB+CCT:

No.	Name	No.	Name
1	RGB jump	6	RGB fade in and out
2	RGB smooth	7	Red fade in and out
3	6 color jump	8	Green fade in and out
4	6 color smooth	9	Blue fade in and out
5	Color temperature smooth	10	White fade in and out