

SP100-24VLT

DATA SHEET



SP100-24VLT

DESCRIPTION

Brief Description

100W Constant Voltage Triac-Dimmable LED Driver 24VDC 0.42-4.17A IP20.

PHYSICAL CHARACTERISTICS

Colour Finish White

MECHANICAL SPECIFICATION

Item Nett Weight (kg) 0.48kg
 Length (mm) 195mm
 Width (mm) 67.1mm
 Height (mm) 31.2mm

ELECTRICAL & SAFETY SPECIFICATION

Protection Class Class 2 - Double Insulated
 Dimmable Yes
 IP Rating IP20

QUALITY STANDARDS

Average Life (hrs) 50000hrs
 Warranty (yrs) 5yrs

DIMENSIONS

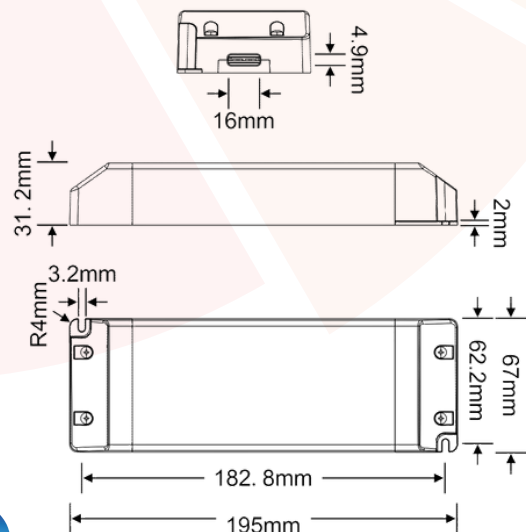

Address: 247 Bilston Road, Wolverhampton, WV2 2JN

E-mail: sales@neselec.co.uk

Website: www.neselec.co.uk

Phone: 01902 458 237