

SPF150-24VSP

DATA SHEET

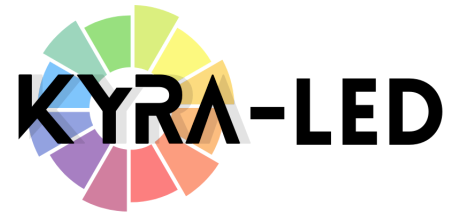

SPF150-24VSP

DESCRIPTION

Brief Description

150W, Constant Voltage Non Dimmable LED Driver, 24VDC, 6.25A, Input 200-240VAC 50/60Hz, IP67.

PHYSICAL CHARACTERISTICS

Colour Finish White

MECHANICAL SPECIFICATION

Length (mm) 155.6mm
 Width (mm) 47.6mm
 Height (mm) 32.5mm

ELECTRICAL & SAFETY SPECIFICATION

Protection Class Class 2 - Double Insulated
 Dimmable No
 IP Rating IP67

QUALITY STANDARDS

Average Life (hrs) 50000hrs
 Warranty (yrs) 5yrs

DIMENSIONS

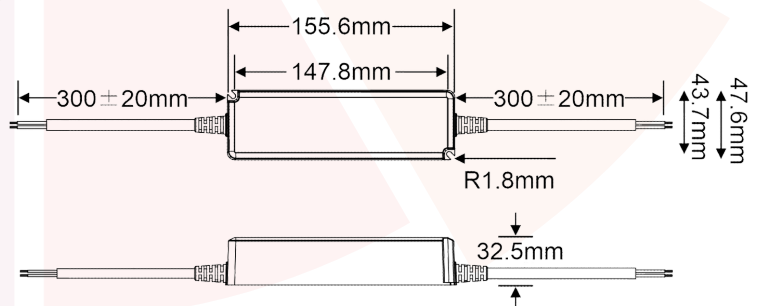
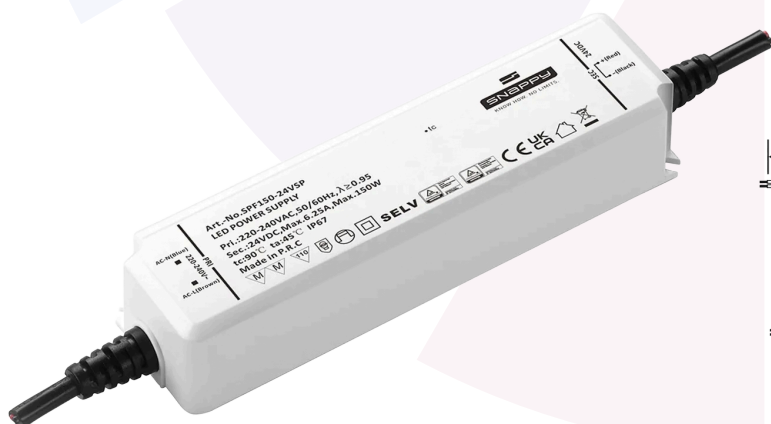

Address: 247 Bilston Road, Wolverhampton, WV2 2JN

E-mail: sales@neselec.co.uk

Website: www.neselec.co.uk

Phone: 01902 458 237